



TAI-SAW TECHNOLOGY CO., LTD.

No. 3, Industrial 2nd Rd., Ping-Chen Industrial District,
Taoyuan, 324, Taiwan, R.O.C.

TEL: 886-3-4690038 FAX: 886-3-4697532

E-mail: tstsales@mail.taisaw.com Web: www.taisaw.com

Product Specifications Approval Sheet

Product Name: 827.4 MHz 4.5 MHz BW SMD 13.3 x 6.5 mm SAW IF Filter

TST Parts No.: TB1022A

Customer Parts No.: _____

Customer signature required
Company: _____
Division: _____
Approved by : _____
Date: _____

Checked by: _____ Kazuma Lee 

Approval by: _____ Francis Chen 

Date: _____ 11 / 08 / 2011

1. Customer signed back is required before TST can proceed with sample build and receive orders.
2. Orders received without customer signed back will be regarded as agreement on the specifications.
3. Any specifications changes must be approved upon by both parties and a new revision of specifications shall be released to reflect the changes.



TAI-SAW TECHNOLOGY CO., LTD.

No. 3, Industrial 2nd Rd., Ping-Chen Industrial District,
Taoyuan, 324, Taiwan, R.O.C.

TEL: 886-3-4690038 FAX: 886-3-4697532

E-mail: tstsales@mail.taisaw.com Web: www.taisaw.com

IF SAW Filter 827.4MHz SMD 13.3X6.5mm

MODEL NO.: TB1022A

REV. NO.1

A. MAXIMUM RATING:

1. Operating temperature range: -20°C to 70°C
2. Storage temperature range: -40°C to 85°C
3. Input Power Level : 10 dBm
4. Maximum DC Voltage : 10V

RoHS Compliant
Lead free
Lead-free soldering

Electrostatic Sensitive Device

B. Characteristics :

1. Ambient Temperature: 25 °C

Characteristics	Value		
	Min.	Typ.	Max.
Center frequency MHz	-	827.4	-
Maximum Insertion loss I.L. dB	-	12.5	14.0
1dB Band Width MHz	4.5	5.0	-
20dB Band Width MHz	-	7.8	-
Passband Ripple at $F_C \pm 2.25$ MHz dB	-	0.4	-
Absolute Group Delay usec	-	0.48	-
Attenuation:(Reference level from Min IL)			
$F_c \pm 4.1$ MHz	10	20	-
Single Input Impedance Ohm	-	50	-
Single Output Impedance Ohm	-	50	-
Temperature Coefficient ppm/°C ²	-	-0.036	-

C. Frequency Characteristics :

(1) Narrow band Response:(span 50MHz)

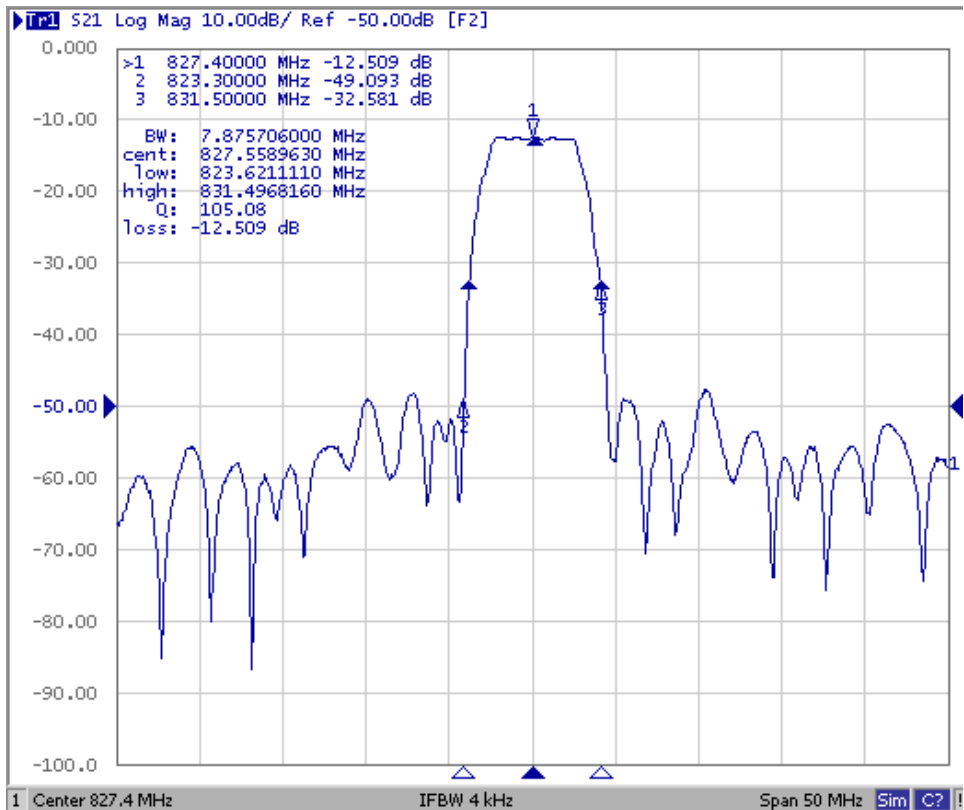

Fig1. Horizontal: 5MHz/Div Vertical: 10dB/Div

(2) Pass band Response and Group Time Delay response:

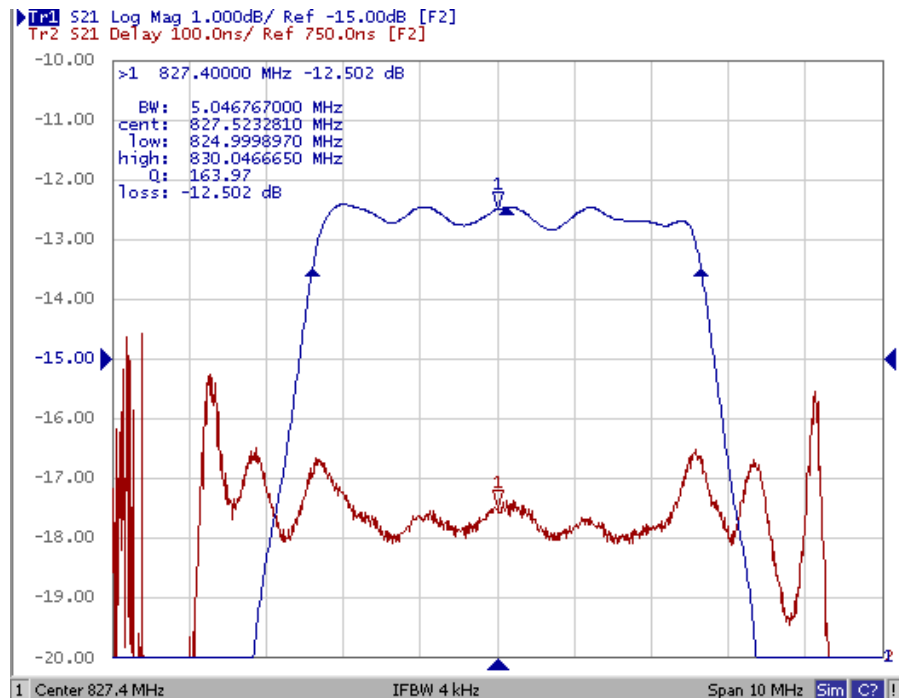
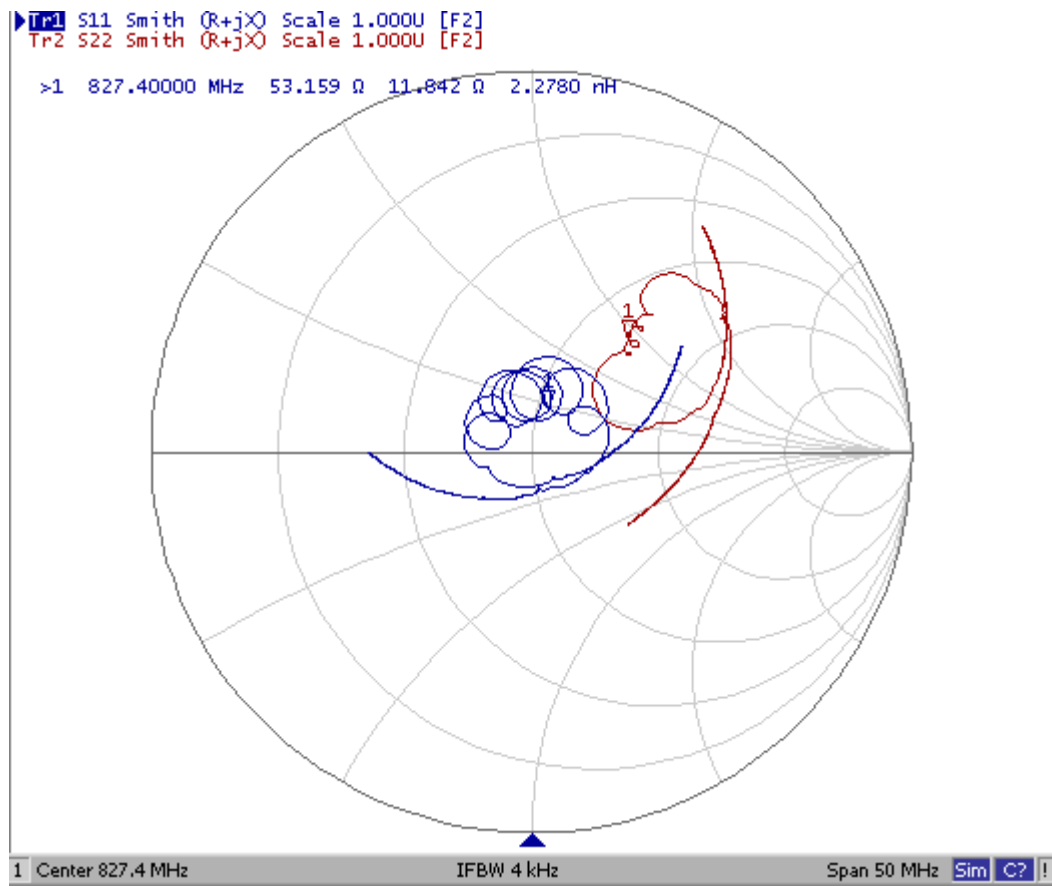
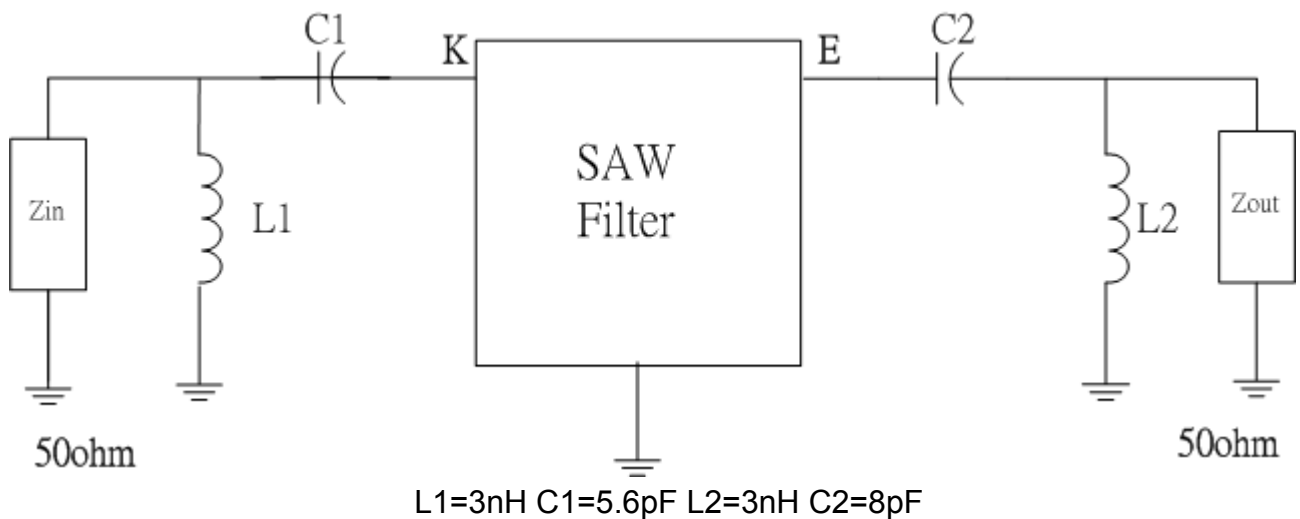

Fig2. Horizontal: 1MHz/Div Vertical: 1dB/Div
Vertical: 100ns/Div

(3) Smith Chart:



D. Matching Circuit:



E. Outline Drawing:

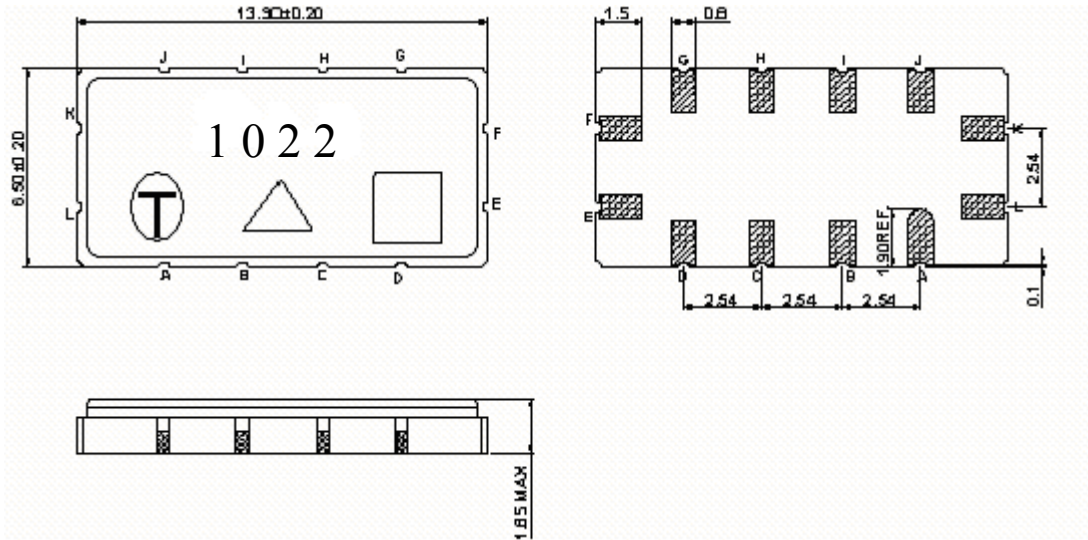

- #K : Input
- #L : Input Ground
- #E : Output
- #F : Output Ground
- #A,B,C,D,G,H,I,J : Ground
- : Week Code (Follow the table from planner each year)
- Unit: mm
- △ : Product / Year Code

Year	2009 2013	2010 2014	2011 2015	2012 2016
Product Code	B	b	<u>B</u>	<u>b</u>

F. PCB Footprint:

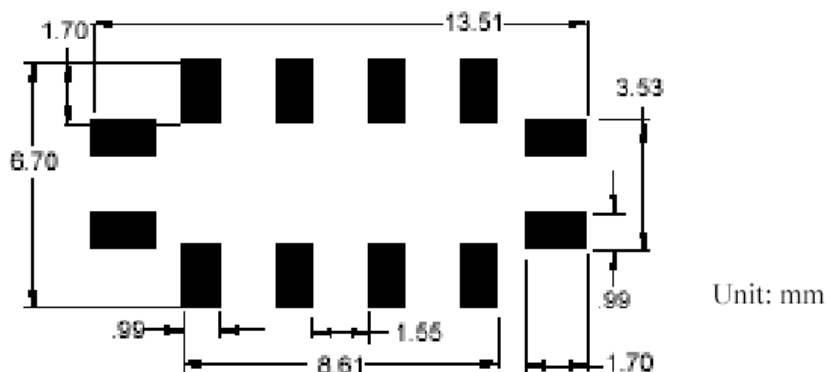

G. PACKING:

1. REEL DIMENSION

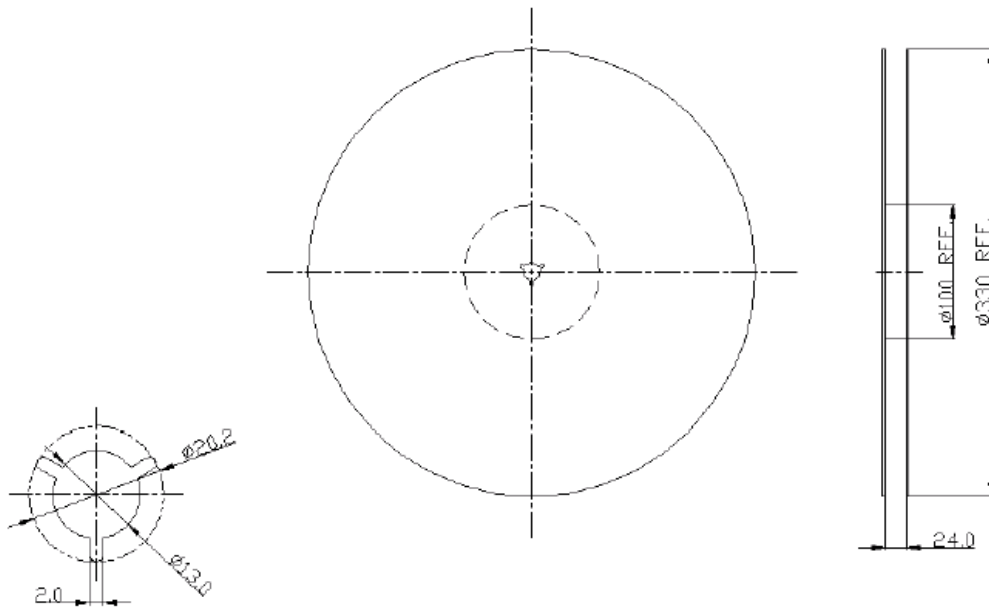

2. TAPE DIMENSION

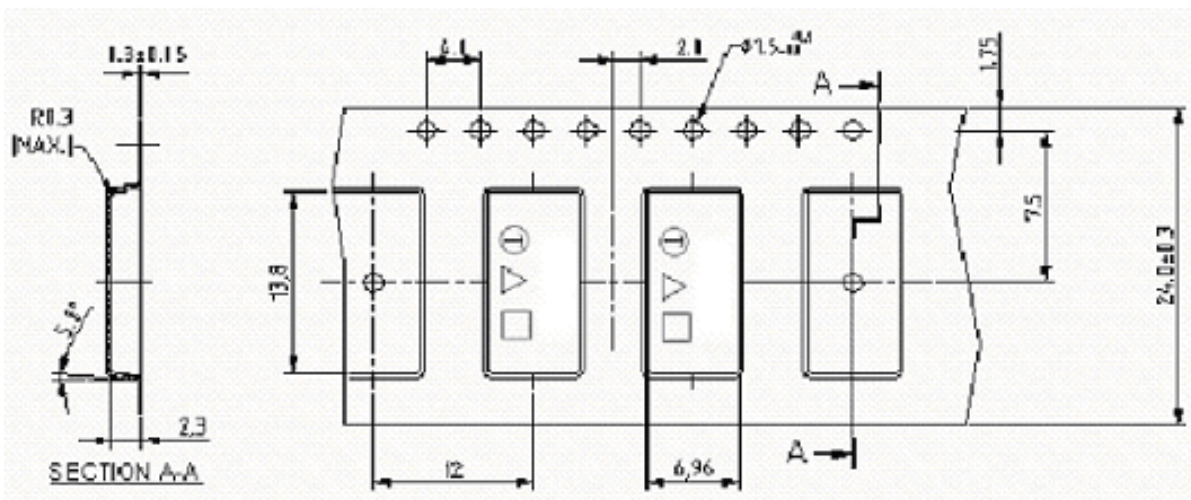

H. RECOMMENDED REFLOW PROFILE_:

